

活動工作站，具有廣泛、多變化之
活動空間運用，適合於各種特殊環
境需要

結構圖

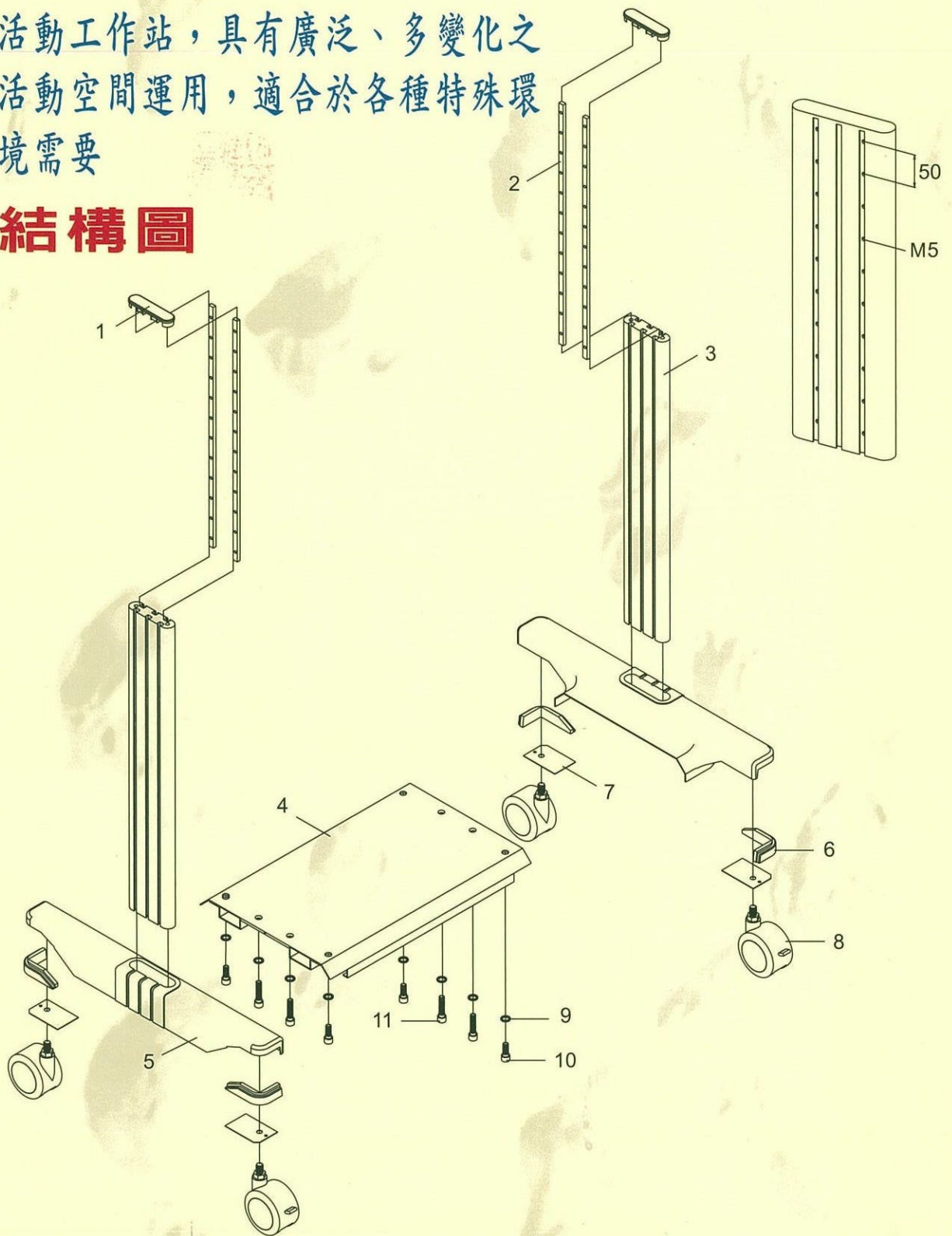

標準配備 Accessories of Standard Model

頂次/NO	品名規格/ITEM	材料/MATERIAL	數量/QUANTITY
01	上蓋	塑膠Plastic	2
02	孔條	AL6063-T5	4
03	支柱	AL6063-T5	2
04	底框	SPCC T=2.0mm	1
05	腳架	鋁壓鑄ADC-12	2
06	防撞護條	橡膠Rubber	4
07	護條墊片	SPCC T=1.2mm	4
08	PU活動輪	100mm雙輪PU	4
09	M12彈簧墊圈	高碳鋼	8
10	M12x30內六角螺絲	合金鋼	4
11	M12x45內六角螺絲	合金鋼	4

Type 1

Type 2

Type 3

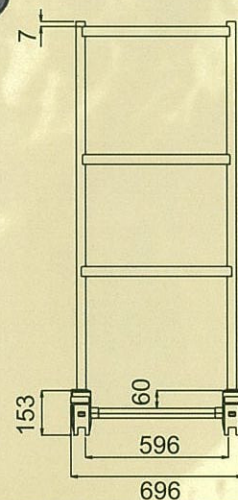
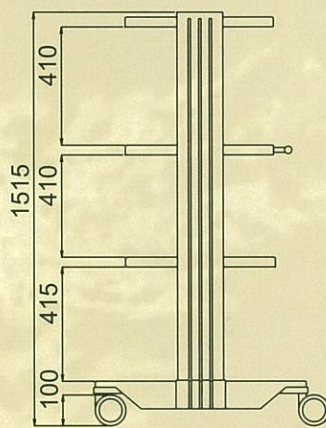
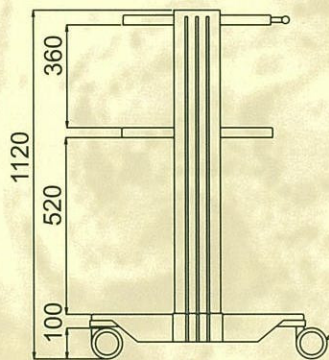
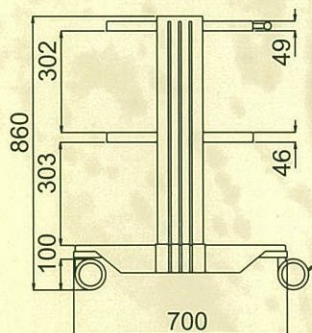

尺寸規格表

Ralab mobile workstation		Type 1 (型式1)	Type 2 (型式2)	Type 3 (型式3)
model no	型號	MW86	MW112	MW151
Height mm	高度	860	1120	1515
width mm	寬度	696	696	696
Depth mm	深度	700	700	700
基本框件(腳架底框支柱孔條)		●	●	●
4"活動輪 前2輪煞車		●	●	●
把手固定平盤		●	●	●
固定平盤(一)		●	●	●
固定平盤(二)		—	—	●
基本框架重量		29.5kgs	31kgs	39.5kgs

擴充配備

	尺寸	最大承載重量
把手固定平盤	596(W)x570(D)x49(H) m/m	60 kg
固定平盤	596(W)x490(D)x49(H) m/m	60kg
抽拉式鍵盤台+滑鼠墊	596(W)x490(D)x50(H) m/m	20kg
抽屜附鎖	596(W)x490(D)x150(H) m/m	20kg
三孔八只式電源組(110V/220V)	具突波保護器，最大負載電源15A	

特殊尺寸亦接受訂製

RADISTAR

基本配備

擴充配備



支柱/上蓋



抽拉式鍵盤台/滑鼠墊

WxDxH	m/m	載重
596x492x50		20kg



三孔八只式電源組

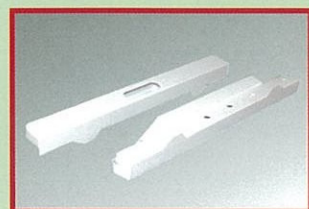

鐵腳架

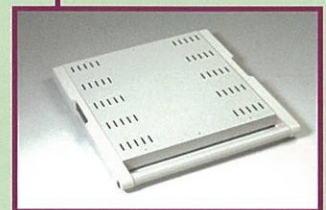
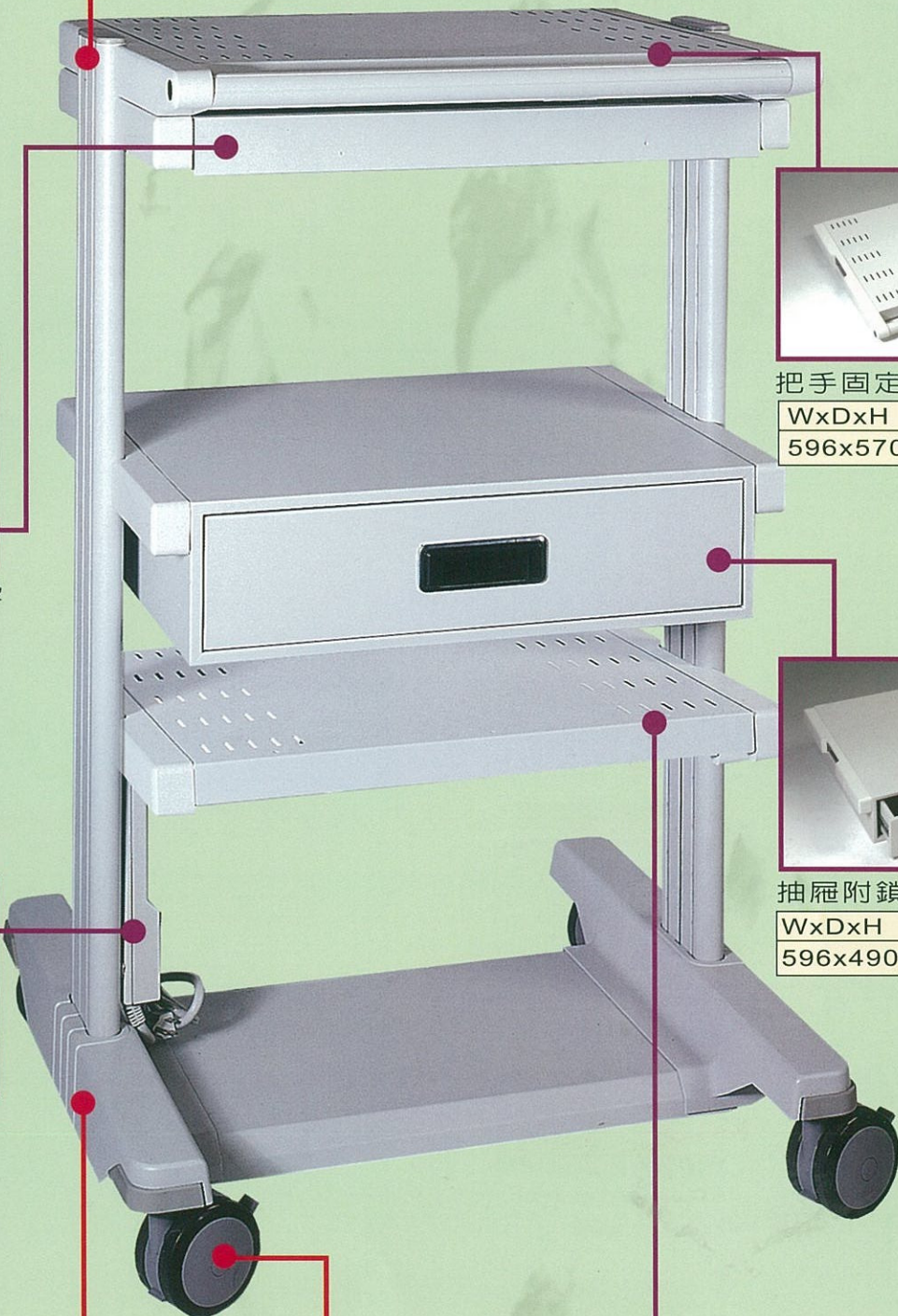

把手固定平盤

WxDxH	m/m	載重
596x570x49		60kg



抽屜附鎖

WxDxH	m/m	載重
596x490x150		20kg



4"活動輪x4
前煞車輪x2

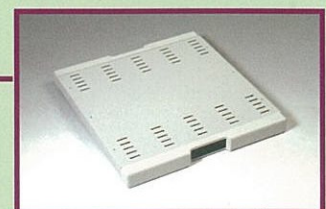

固定平盤

WxDxH	m/m	載重
596x490x49		60kg

範例 1

示波器/分析儀

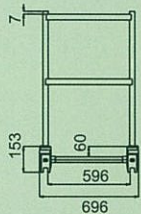
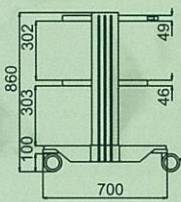
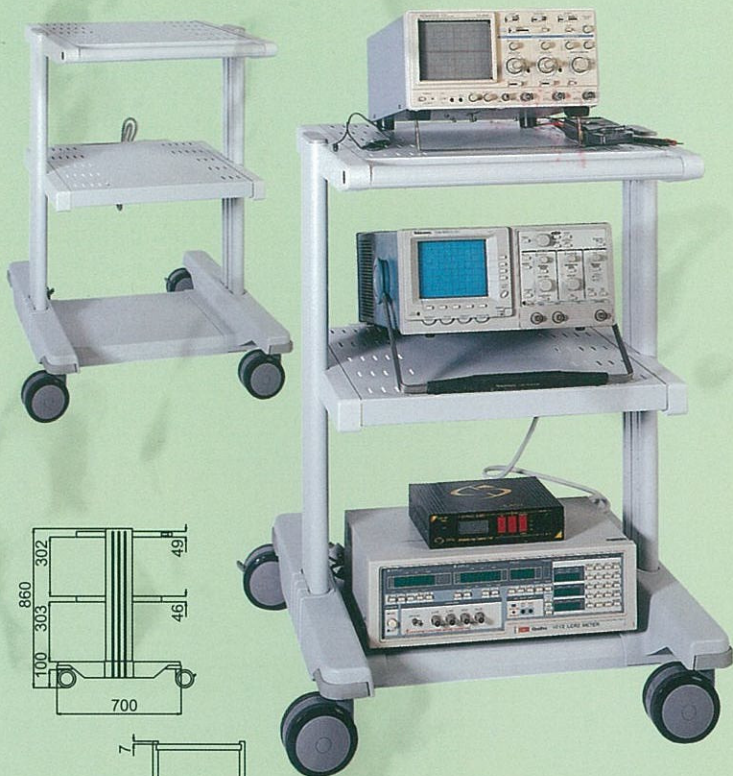

TYPE1 MW86
696mm(w)x860mm(H)700MM(D)
1.基本框架
2.固定平盤X1
3.把手固定平盤X1
4.電源組X1(擴充)

範例 2

電腦機架

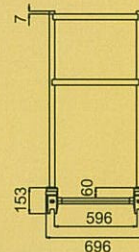
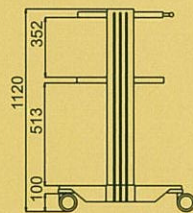

TYPE2 MW112
696mm(w)x1120mm(H)700MM(D)
1.基本框架
2.固定平盤X1
3.鍵盤台X1(擴充)
4.抽屜X1(擴充)
5.把手固定平盤X1
6.電源組X1(擴充)

範例 3

A/V音響 · 卡拉OK

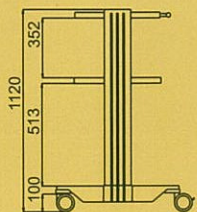
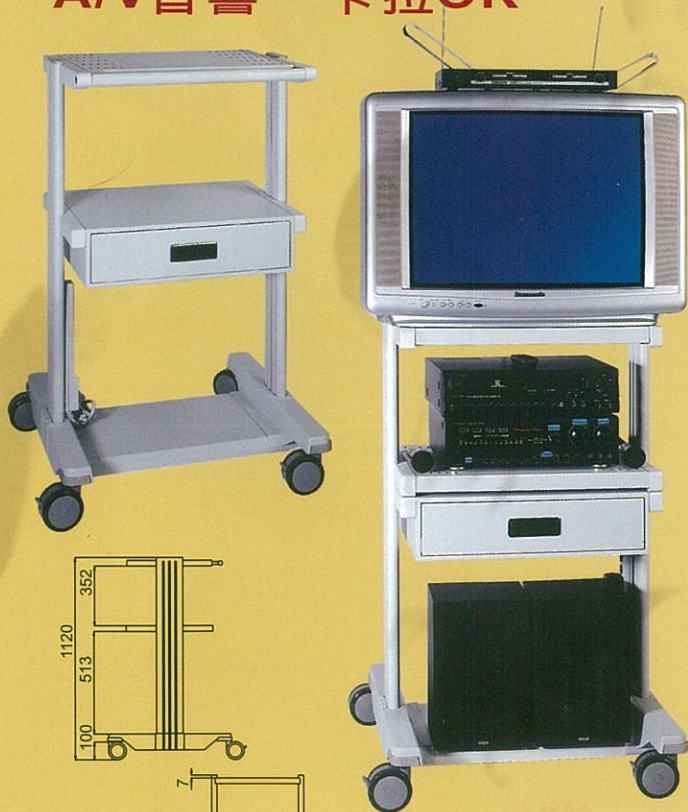

TYPE2 MW112
696mm(w)x1120mm(H)700MM(D)
1.基本框架
2.固定平盤X1
3.抽屜X1(擴充)
4.電源組X1(擴充)
5.把手固定平盤X1
6.電源組(擴充)

範例 4

特殊訂製尺寸

FILE/LAN SERVER

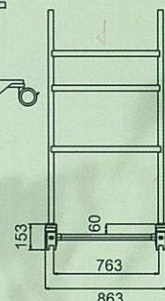
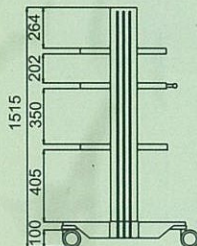

TYPE3 MW151
863mm(w)x1515mm(H)700MM(D)
1.基本框架
2.把手固定平盤X1
3.固定平盤X2
4.鍵盤台X1(擴充)
5.電源組X1(擴充)